

Under-Cabinet Radio

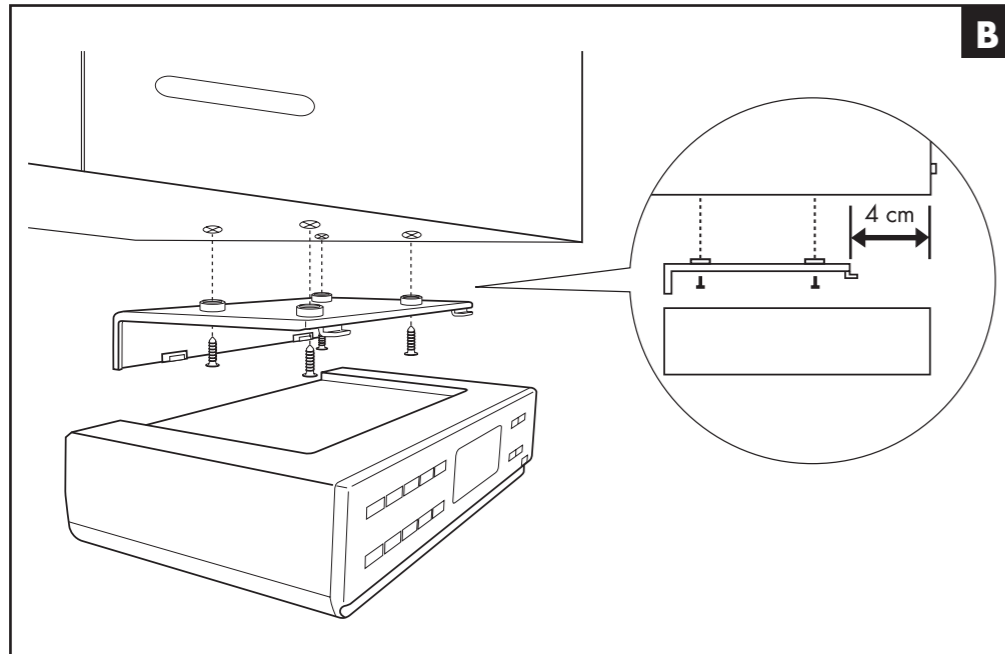

GB Under-Cabinet Radio
IE Operating manual
CY



INDEX	PAGE
Intended Use	2
Items supplied	2
Technical data	2
Safety instructions	2
The appliance components	4
Setting up the appliance	4
Fixing the kitchen radio beneath a wall cabinet	5
Setting up the kitchen radio	5
The Settings menu	5
Further setting possibilities	7
Radio operation	8
Non-functionality	10
Cleaning	10
Disposal	11
CE Conformity	11
Importer	11
Warranty and Service	11

Read the operating instructions carefully before using the appliance for the first time and preserve this booklet for later reference. Pass this booklet on to whoever might acquire the appliance at a future date.

Intended Use

This Kitchen Radio is intended for use either free-standing or for assembly beneath a wall cabinet. The intended uses for this Kitchen Radio are the reception of FM radio transmissions and as an alarm/timer, using either signal tones or the radio itself.

This Kitchen Radio is not intended for utilisation in commercial or industrial applications. The warranty does not provide compensation for damage caused by improper use of the appliance!

Items supplied

- 1 Kitchen radio KH 2398
- 1 Mounting plate
- 4 Screws
- 2 Batteries type AAA/Micro
- 1 Operating manual

Technical data

Power supply:	220-240V~, 50 Hz
Power consumption:	
Operation:	5 W
Standby:	approx. 1.8 W
Output level:	1 W at 10% THD
Frequency range	FM 87.5-108 MHz
Operating temperature:	+5 ~ +35 °C
Humidity:	5 ~ 90 % (No condensation)

Dimensions (W x H x D):	27,5 x 16 x 6,3 cm
Weight:	1.045 g
Protection class:	II / 
Backup batteries AAA/Micro	2 x 1.5 V Type

The technical features of this appliance enable an adjustable reception capability that exceeds the permitted frequency range of 87,5-108 MHz. In some countries, different national regulations may apply to the assigned radio frequency ranges. Please note that information received outside of the

assigned radio frequency ranges may not be utilised, passed on to third parties or otherwise misused.

Safety instructions

- This appliance is not intended for use by individuals (including children) with restricted physical, physiological or intellectual abilities or deficiencies in experience and/or knowledge unless they are supervised by a person responsible for their safety or receive from this person instruction in how the appliance is to be used. Children should be supervised to ensure that they do not play with the appliance.
- Always remove the power plug before cleaning the appliance.
- Check the appliance and all parts for visible damages. The safety concept can work only if the appliance is in a faultless condition.
- The power plug must always be easily accessible, so that in the event of an emergency the appliance can be quickly disconnected from the mains power supply.



Risk of electrical shocks.

- Connect the appliance only to correctly installed and earthed mains power sockets. Ensure that the rating of the local power supply tallies completely with the details given on the rating plate of the appliance.
- Arrange for Customer Services to repair or replace connecting cables and/or appliances that are not functioning properly or have been damaged.
- NEVER submerge the appliance in water. Wipe it only with a slightly damp cloth.
- Do not expose the appliance to rain and never use it in a humid or wet environment.

- Always take hold of the power cable by the plug. Do not pull on the cable itself and never touch the power cable with wet hands, this could result in either a short circuit or you receiving an electric shock.
- Do not place the appliance, furniture or anything else on the power cable and ensure that it does not become clamped.
- NEVER make a knot in the power cable and do NOT bind it together with other cables. The power cable should be positioned so that no one can step on or trip over it.
- Ensure that the power cable does not become wet during operation.
- You are not permitted to open the appliance housing or repair the appliance. If the housing is opened, you run the risk of receiving a potentially fatal electric shock and the warranty lapses.
- Protect the appliance against drip and spray water. Do not place any water-filled vessels (e.g. flower vases) on or near the appliance.

Risk of fire!

- Do not use the appliance near hot surfaces.
- Do not install the kitchen radio close to sources of heat such as radiators or stoves. Otherwise, it may overheat and become irreparably damaged.
- Do not locate the kitchen radio directly above hotplates. The kitchen radio may be damaged. There is a danger of fire!
- Never leave the appliance unattended while it is being used.
- Never cover the ventilation slots of the appliance while it is on.
- Do not place open fire sources, such as candles, on or near the appliance.

Risk of personal injury!

- Keep the power cable and appliance away from children. Children frequently underestimate the dangers of electrical appliances.

- Provide a stable location for the appliance.
- Do not operate the appliance if it has sustained a fall or is damaged.
- Arrange for the appliance to be checked and/or repaired by qualified technicians.
- Keep batteries well away from children. Children can put batteries into their mouths and swallow them.
- If a battery is swallowed medical assistance must be sought immediately.

Note:

- Some aggressive furniture finishes can have a destructive influence on the appliance's rubber pads. If necessary, place the appliance on a nonslip pad.

Thunderstorms!

- Equipment connected to a power supply can be damaged during a thunderstorm. You should therefore always remove the plug from the power socket when there is a storm.

Notice regarding separation from mains-power

The ON/OFF switch does not completely disconnect the appliance from the power network. Additionally, the appliance consumes power when in standby-mode.

To completely separate the appliance from mains power, the power plug MUST be removed from the mains power socket.

Notice regarding electrical power surges (EFT /electrical fast transient) and electrostatic discharges:

In a case of malfunction due to an electrical fast transient (power surge) and/or electrostatic discharge, the appliance must be returned to default settings in order to re-establish normal operation. Possibly the power supply must be separated and then reconnected. The batteries (if

present) must be removed and then re-inserted.

Information regarding the handling of batteries

The appliance uses batteries for memory conservation. For the handling of batteries please observe the following:

Risk of explosion!

- Do not subject the batteries to excessive heat such as fire, sunlight or similar. Do not recharge the batteries.
- Never open batteries, never solder or weld batteries. The risk of explosions and injuries exists!
- Regularly check the condition of the batteries. Leaking batteries can cause damage to the appliance.
- If you do not intend to use the appliance for an extended period, remove the batteries.
- Should the batteries leak, put on a pair of protective gloves and clean the battery compartment and terminals with a dry cloth.

Important!

No liability/warranty will be considered for damage to the Kitchen Radio caused by the effects of moisture, water penetration or overheating!

The appliance components

(See fold-out illustration "A")

- ① Mounting plate/Baseplate
- ② Power cable
- ③ Wire aerial
- ④ - ⑦ M1 - M4 - Memory buttons M1 - M4
Alarm 1-4 - Alarm buttons 1-4
- ⑧ DIMMER /AOT - controls the display lighting, controls the switch-off timer
- ⑨ Display
- ⑩ VOL - - Volume down
- ⑪ VOL + - Volume up

- ⑫ USER/BASS - User switching, Bass boost
- ⑬ MEM SCAN - for the automatic recall of saved radio stations
- ⑭ TIMER - control for the timer programming
- ⑮ MEM SET /AMS - to save and automatically search and save radio stations
- ⑯ MODE/ - Calls up the settings, Key lock
- ⑰ Battery compartment
- ⑱ DOWN ▼ - Selection button down
- ⑲ UP ▲ - Selection button up
- ⑳ ON/OFF - Radio on/off

Setting up the appliance

First take all appliance components from the packaging and remove all packing foil and tape.

Inserting the back-up batteries

The back-up batteries ensure that the time, date and alarm time setting are not lost in the event of a power cut. For this you require two 1.5 V batteries of the type AAA/Micro.

1. Open the lid of the battery compartment ⑰ on the underside of the kitchen radio.
2. Insert the batteries. Make sure the polarities are correct. Otherwise, the memory receipt will not function and damage may be caused to the appliance.
3. Close the lid of the battery compartment ⑰. The lid must audibly engage.

Note:

The back-up batteries must be checked at least once per year and, if necessary, exchanged for new ones.

Fixing the kitchen radio beneath a wall cabinet

With the supplied mounting plate ❶ you can fix the kitchen radio below, for example, a kitchen wall cabinet:

1. Determine a suitable location for the kitchen radio.
2. Press the two retaining levers on the back of the appliance down. Push the mounting plate ❶ back and remove it.
3. Hold the mounting plate ❶ under the installation location. Thereby, the front edge of the mounting plate ❶ should be approx. 4 cm behind the front of the kitchen cabinet (See fold-out illustration "B").
4. Mark the four points for the drillholes with a pencil.
5. Using a spike, make a small depression at the marking points. Firmly secure the mounting plate ❶ with the supplied screws.
6. Hold the kitchen radio slanted, with the two recesses in the retaining lugs on the mounting plate ❶. Press the kitchen radio upwards until it perceptibly engages.

Disassembly

- To disassemble the kitchen radio, press the two retaining levers at the rear of the appliance downwards. Then pull the radio out to the front and remove it.
- Unscrew the screws and remove the assembly plate ❶.

Setting up the kitchen radio

Do not set the kitchen radio up without the mounting plate ❶. Otherwise the speakers are covered and the sound is scarcely audible.

To fit the kitchen radio with the supplied mounting plate ❶:

1. Simultaneously press the two retaining levers on the back of the appliance down. Push the mounting plate ❶ back and remove it.

2. Push the two rear retainer lugs on the mounting plate ❶ into the recesses on the lower side of the kitchen radio.
3. Press the mounting plate ❶ firmly into the appliance underside until it perceptibly engages.

Providing mains power

- When you have completed installation of the appliance, insert the plug into a mains power socket. The display ❸ is illuminated and the appliance tries to receive an RDS signal to automatically adjust the time and date.
- For as long as the appliance waits for the RDS signal, the display ❸ shows "PLEASE WAIT FOR SETTING THANKS". This can take several minutes. To hide this notice, press the button MODE/⏸ ❶.

The Settings menu

Setting the time

Should this not succeed, you must set the clock manually. For this, the radio cannot be switched on (= automatic mode).

1. In automatic mode press the button MODE/⏸ ❶ once. The time display blinks.
2. Press the buttons UP▲/DOWN▼ ❸/❹ to set the time in minute intervals. Pressing and holding the button changes the time at ten-minute intervals.
3. Press the button MODE/⏸ ❶ once again to save the time and switch to the date setting.

If you do not press a button for 15 seconds when making the settings, the appliance saves the current setting and returns to automatic mode.

Setting the date

1. In automatic mode press the button MODE/⏸ ❶ twice. In the display ❸ appears "01.01.2010", the date display flashes.

2. Press the buttons UP▲/DOWN▼ 19/18 to set the date at day intervals. Pressing and holding the buttons changes the date at intervals of 10 days.
3. Press the button MODE/☰ 16 once again to save the date and to switch to setting the memory function.

If you later press the DOWN button ▼ 18 in automatic mode, the display 9 briefly shows "DAY". Subsequently, the time and date display alternate themselves. To switch back to an exclusive time display, press the button DOWN▼ 18 once again.

Setting the memory functions

You can programme in up to 6 dates, which the appliance will remind you of when they are reached.

1. In automatic mode press the button MODE/☰ 16 three times. The display 9 shows alternatively a date and the SDA 1 indicator for reminder date 1.
2. Press the buttons UP▲/DOWN▼ 19/18 to set the first desired reminder date. As the earliest possible date you can set the following day. Pressing and holding one of the buttons changes the display in ten-minute intervals.
3. When you press the button TIMER 14, the year number is deactivated and thus you are reminded on this date every year.
4. Should you wish to programme in further SDA's, press the button MEM SCAN 13 to select the desired memory positions 2-6. The selected memory location (SDA 2-6) will be indicated in the display 9.
5. Follow the same steps with the other dates.
6. To deactivate the memory function, programme in a date that lies in the past.
7. Press the button MODE/☰ 16 once again to save the settings of the memory function and to switch to setting the update function.

The appliance will remind you of a date that you have set with the reminder function. Then, on this given day from 08:00 – to 23:00, and on every full hour, the acoustic reminder alarm sounds for 10 minutes if you do not stop the alarm. In addition, the SDA-panel in the display 9 blinks. To stop the reminder alarm, press any button.

Setting the update function

Using this function, the appliance can automatically update the settings for the clock based on the RDS data.

1. In automatic mode press the button MODE/☰ 16 four times. The display 9 shows "UP DATE".
2. Press the button DOWN▼ 18, to deactivate the actualisation function. The blinking clock symbol ⌚ in the display 9 then disappears.
3. Press the button UP▲ 19 to reactivate the update function. The hour symbol ⌚ appears.
4. Press the button MODE/☰ 16 once again to save the settings of the update function (the display flashes for 15 seconds, after that the saving is finalised) and to switch to setting the 12 or 24 hour mode.



Setting the dimmer function

In automatic mode press the button MODE / ☰ 16 five times. Or press and hold the button DIMMER/AOT 8 to set the dimmer function outside of the Settings menu. In the display 9 appears either *DIM ON* (delivery state) or *DIM OFF*. Press and hold the button DIMMER/AOT 8 once again to change the dimmer setting.

DIM ON: The display 9 lights up for 15 seconds when a button is pressed.

DIM OFF: The display 9 is permanently lit.

Selecting 12 or 24 hour time display



1. In automatic mode press the button **MODE/**  **16** six times. In the display **9** appears "24 HOUR" for the 24 hour modus.
2. Press the button **DOWN**  **18** to select the 12 hour modus. In the display **9** appears "12 HOUR". Press the button **UP**  **19** to return to the 24 hour modus.

In the 12 hour mode, „PM“ (post meridiem = afternoon) appears before the time indicator in the display **9** from 12:00 to 23:59.

Press the button **MODE/**  **16** to save the menu settings and to close it down.

Further setting possibilities

Kitchen timer

1. Press the button **TIMER** **14**.
2. Using the buttons **UP**  **19**/**DOWN**  **18**, set the desired time interval (a time span between 1 minute and 23:59 h is possible). Pressing and holding one of the buttons changes the display in ten-minute intervals. Or press one of the buttons **M1** - **M4** **4** - **7** to recall a saved preset time for the kitchen timer. The following times are factory pre-programmed:
M1 **4** = 5/25 min. (Indicator = T1/5)
M2 **5** = 10/30 min. (Indicator = T2/5)
M3 **6** = 15/35 min. (Indicator = T3/7)
M4 **7** = 20/40 min. (Indicator = T4/8)
3. Press the button **TIMER** **14** once again to start the kitchen timer. In the display **9** a clock icon running in reverse and a cooking pot symbol appears.
4. From 30 seconds before expiry of the time span an acoustic signal sounds, repeating at shorter intervals the closer the set time approaches. When the time has expired, the alarm sounds continuously and with increasing volume.
5. Press the button **TIMER** **14** to terminate the acoustic signal.

Interrupting the kitchen timer.



- To interrupt the kitchen timer, switch to the kitchen timer mode by pressing the button **TIMER** **14**.
- Then briefly press the button **TIMER** **14** to interrupt the kitchen timer.

The time is halted, the indicator blinks for 15 seconds. After this period the appliance returns to automatic modus. To restart the kitchen timer, briefly press the button **TIMER** **14** again to switch back into the kitchen timer mode.

- Press the button **TIMER** **14** once again. The time then continues to run.
- To completely switch the kitchen timer off, press and hold the button **TIMER** **14** for 3 seconds. The clock and cooking pot symbol disappear.

Programming the kitchen timer



You can programme frequently used times for the kitchen timer into the appliance, so that you do not need to enter them repeatedly. As the appliance can be used by several people, it has user switching, A/B. Both users can save 8 different timer periods each.

1. First, select the desired user. To switch between users, press and hold the button **USER/BASS** **12** for two seconds. Depending on the selected user, the display **9** indicates either "A" or "B".
2. Then press the button **TIMER** **14**.
3. Using the buttons **UP**  **19**/**DOWN**  **18** enter in the desired time.
4. Press the button **MEM SET/AMS** **15**. On the right and next to the time indicator, "T" lights up.
5. In order to occupy one of the memory locations 1 - 4, press the desired memory location button **M1** - **M4** **4** - **7** under which the time for the kitchen timer should be saved once. Its number is now shown to the right of the "T". To occupy one of the memory locations 5 - 8, press the desired memory location button **M1** - **M4** **4** - **7** twice.

- Press the button MEM SET/AMS 15 once again to conclude the saving. The display flashes for 15 seconds, after that the saving is finalised.

Setting alarm times (Alarm 1–4)

You can programme four alarm times with your kitchen radio.

Alarm function	Symbol in the display 9
Acoustic signal	
Radio	
Switched off	no symbol

- In automatic mode, press one of the ALARM buttons 1–4 4–7 to select the location for the to be programmed alarm memory. In the display 9 the last set alarm time and the symbol for the type of alarm blink for 15 seconds.
- Press the buttons UP▲/DOWN▼ 19/18 to set the desired alarm time.
- Repeatedly press the ALARM button previously pressed until the desired alarm function (see table above) is indicated in the display 9.
- Repeatedly press the button TIMER 14 to set the weekdays on which you require the alarm function: You can select between "workdays" (Mo, Tu, We, Th, Fr), "weekends" (Su, Sa) and "every day" (Su, Mo, Tu, We, Th, Fr, Sa). Thereby, orientate yourself on the weekday indicator in the display 9:

Mo	= Monday
Tu	= Tuesday
We	= Wednesday
Th	= Thursday
Fr	= Friday
Sa	= Saturday
Su	= Sunday.
- If you hold the button TIMER 14 pressed down for 2 seconds, you can also,

through repeated brief pressing of the TIMER 14 button, select a specific weekday (e.g. only "We"). The selected setting is indicated in the display 9.

- To return to the selection of workdays, weekends or whole weeks, once again hold the button TIMER 14 pressed down for 2 seconds.
- After 15 seconds the blinking in the display stops and your input is saved. The appliance then returns to automatic modus.

When the alarm signal sounds...

- and the alarm function "Radio" has been selected, the radio plays for one hour at a pre-defined alarm volume. To exit, press one of the ALARM buttons 1–4 4–7.
- and the alarm function "Signaltones" has been selected, the signal tone sounds for 10 minutes, with an increasing volume. To exit, press one of the ALARM buttons 1–4 4–7.

Radio operation

For radio reception, completely unwind the wire aerial 3 and, with the radio switched on, determine the most favourable positioning for it.

Switching the radio on and off

- To switch the radio function on, press the button ON/OFF 20. In the display 9 the currently selected frequency is shown.
- Press the button ON/OFF 20 once again to switch the radio off and return the appliance to the automatic modus.

Manual station selection

- Briefly press the button UP▲ 19 repeatedly to search for stations with a higher frequency than the one shown in the display 9.
- Briefly press the button DOWN▼ 18 repeatedly to search for stations with a lower frequency than the one shown in the display 9.

- Should the currently adjusted station transmit RDS data, the **RDS** indicator in the display **9** blinks. Then the display **9** shows the name of the radio station, and the time is updated (if activated in the settings, see section "Setting Update function"). During a running time update via RDS the clock icon in the display **9** flashes.

Automatic station search

You can have the kitchen radio search for stations. The kitchen radio searches the frequency range until it finds a station.

- Press and hold the button UP▲ **19** for two seconds: the kitchen radio searches for the station with the next highest frequency.
- Press and hold the button DOWN▼ **18** for two seconds: the kitchen radio searches for the station with the next lowest frequency.

Repeat these steps until you have found a radio station to your liking.

Save and recall a radio station manually

As the appliance can be used by numerous people, it is fitted with user switching, A/B. Both users can save different radio stations. To switch between users, press and hold the button USER/BASS **12** for two seconds.

Each user can save 32 radio stations in the appliance. Available for this are:

- Preset button M1 **4** for the save positions A0 - A7,
- Preset button M2 **5** for the save positions B0 - B7,
- Preset button M3 **6** for the save positions C0 - C7, and
- Preset button M4 **7** for the save positions D0 - D7.

Press the corresponding preset button once to address the save position "0", press twice for "1", etc.

- Set the user and the desired radio station.
- Press the button MEM SET/AMS **15**. In the display **9** the "MEM" indicator blinks.

If the memory location button **4** - **7** has been pressed previously, the memory location indicator and the MEM" indicator blink.

- Press one of preset buttons M1 - M4 **4** - **7**, if necessary repeatedly, to save the radio station to the desired save position. In the display **9**, the indicator for the save position selected by you and "MEM" blink.
- Press the button MEM SET/AMS **15** once again. "MEM" and the save position are constantly indicated, the radio station is saved.
- Repeat the steps 1 to 4 (for both users) until all of the desired radio stations are saved.
- To recall the saved radio stations, press the corresponding preset buttons (M1 - M4 **4** - **7**) in radio mode, several times if need be, until the number of the saved position appears in the display **9**.

Automatically save and recall a radio station

With the AMS function (Automatic Memory System), the radio automatically searches for stations and stores them at the memory locations. Previously saved radio stations are thereby erased.

- Press and hold the button MEM SET/AMS **15** for two seconds. The kitchen radio automatically searches for sufficiently powerful radio stations and saves them in the memory.
- The station search can be stopped by pressing on the button MEM SET/AMS **15**. The most recently found radio station plays.
- When you press the button MEM SCAN **13**, the saved radio stations are recalled in their sequence and each is played for 15 seconds.
- To quickly move on to another radio station, press the button MEM SCAN **13**.
- To quit the automatic recall, press the button MODE/⏏ **16**. The display **9** will then show the time for 15 seconds.

Adjusting the volume.

- To reduce the sound volume, in radio operation repeatedly press the button VOL – ⑩, or hold the button down.
- To increase the sound volume, in radio operation repeatedly press the button VOL. + ⑪, or hold the button down.

Lock function

You can lock the kitchen radio so that settings cannot be altered by unauthorised people or children.

- Press and hold the button MODE/🔑 ⑫ for 3 seconds. A key symbol appears in the display ⑨.
- When a key is pressed and the lock is activated, the key symbol blinks but no other functions are carried out.
- To disable the lock function, press and hold the button MODE/🔑 ⑫ until the key symbol extinguishes.

Bass

Should you wish to have an amplified reproduction of the lower frequencies, press the button USER/BASS ⑬ when in radio modus. In the display ⑨ the indicator "BASS" then appears. Press this button once again to deactivate the function.

Displaying the time

To display the time for 15 seconds during radio operation, press the button MODE/🔑 ⑫.

A.O.T. - Switch-off timer

This appliance is fitted with a switch-off timer for up to 90 minutes.

1. Press the button DIMMER/A.O.T. ⑧ to call the function up and, if need be, to switch the radio on.
2. Repeatedly press the button DIMMER/A.O.T. ⑧ to programme in the number of minutes, in increments of 5 minutes, for which the appliance is to remain switched on. The default setting is 90 minutes. In

the display ⑨ the AOT indicator and a clock symbol appear when the switch-off timer function is activated. After a few seconds, the frequency is indicated once again.

3. At any time you can press the DIMMER/A.O.T. ⑧ button to blend in the remaining countdown time for a few seconds.
4. On expiry of the time period the appliance switches itself off.
5. To simply switch the unit off, press the button ON/OFF ⑳.

Non-functionality

- Do not attempt to take the device apart and/or, in the event of possible defects, to repair yourself. You could potentially damage the sensitive electronic components.
- Repairs to your device must be carried out exclusively by qualified service personnel!
- No warranty/liability will be assumed for damage resulting from improper use and/or opening of the device!
- In the event of malfunction please get in touch with the corresponding service affiliate in your country.

Cleaning

Warning!

Always remove the plug before cleaning the appliance!

Moisture penetrating into the appliance creates the risk of electric shock! Additionally, the kitchen radio could become irreparably damaged!

Clean the housing of the kitchen radio with a slightly moist cloth and a mild detergent only. Ensure that moisture cannot permeate into the appliance during cleaning!

Do not dispose of the appliance in your normal domestic waste. This product is subject to the provisions of European Directive 2002/96/EC.



Disposing of the appliance

- Arrange for the product, or parts of it, to be disposed of by a professional disposal company or by your communal waste facility.
- Observe the currently applicable regulations. In case of doubt, please contact your waste disposal centre.

Disposal of batteries/accumulators

- Used batteries/rechargeable batteries may not be disposed of in household waste.
- Batteries/rechargeable batteries can contain toxic substances which may damage the environment. Therefore, dispose of the batteries/rechargeable batteries in accordance with statutory regulations.
- Every consumer is statutorily obliged to dispose of batteries/rechargeable batteries to a community collection centre in their district or to a dealer. The purpose of this obligation is to ensure that batteries are disposed of in a non-polluting manner.
- Only dispose of batteries when they are fully discharged.

Disposal of packaging

Dispose of all packaging materials in an environmentally friendly manner.



This device complies, regarding conformity, to the basic requirements and other relevant provisions of the Low Voltage Directive 2004/108/EC, the Directive for Low Voltage Appliances 2006/95/EC and the Eco Design Directive 2009/125/EC (Ordinance 1275/2008 Appendix II, Number 1).

Importer

KOMPERNASS GMBH
BURGSTRASSE 21
44867 BOCHUM, GERMANY
www.kompernass.com

Warranty and Service

The warranty for this appliance is for 3 years from the date of purchase. The appliance has been manufactured with care and meticulously examined before delivery. Please retain your receipt as proof of purchase. In the event of a warranty claim, please make contact by telephone with our Service Department. Only in this way can a post-free despatch for your goods be assured.

The warranty covers only claims for material and manufacturing defects, but not for transport damage, for wearing parts or for damage to fragile components, e.g. buttons or batteries. This product is for private use only and is not intended for commercial use.

The warranty is void in the case of abusive and improper handling, use of force and internal tampering not carried out by our authorized service branch. Your statutory rights are not restricted in any way by this warranty.

The warranty period will not be extended by repairs made under warranty. This applies also to replaced and repaired parts. Any damage and defects extant on purchase must be reported immediately after unpacking the appliance, at the latest, two days after the

purchase date. Repairs made after the expiration of the warranty period are subject to payment.

GB DES Ltd

Tel.: 0871 5000 700 (£ 0.10 / minute)

e-mail: support.uk@kompernass.com

IE Kompernass Service Ireland

Tel: 1 850 930 412 (0,082 EUR/Min.)

Standard call rates apply. Mobile operators may vary.

e-mail: support.ie@kompernass.com

CY Kompernass Service Cyprus

Tel.: 800 94401

e-mail: support.cy@kompernass.com